



PSBEN 10A12E

v.1.1

PSBEN 13,8V/10A/65Ah/EN Buffer, switch mode power supply unit Grade 3.

EN**

Edition: 9 from 27.11.2019













Supercedes edition: 8 from 31.01.2019

LED Version

BLACK POWER



TABLE OF CONTENTS

1. PSU FEATURES.	4
2. FUNCTIONAL REQUIREMENTS OF THE PSU COMPLIANT WITH THE EN 50131-6 STANDARD.	5
3. TECHNICAL DESCRIPTION.	6
3.1 GENERAL DESCRIPTION.	6
3.2 BLOCK DIAGRAM.	7
3.3 DESCRIPTION OF PSU'S COMPONENTS AND CONNECTORS.	8
4. INSTALLATION.	10
4.1 REQUIREMENTS.	10
4.2 INSTALLATION PROCEDURE.	10
5. FUNCTIONS.	12
5.1 CONTROL PANEL.	12
5.2 MAIN MENU.	13
5.2.1 Voltage indicator „Uo” 	13
5.2.2 Output current indicator „Io” 	13
5.2.3 Failure history “FLh” 	14
5.2.4 Current failures „FLc” 	14
5.2.5 List of failure codes and information messages.	15
5.3 PSU CONFIGURATION.	17
5.3.1 Battery test ON/OFF „tSt” 	18
5.3.2 LED Display Dimmer „dIS” 	19
5.3.3 Setting the communication address „Adr”   applies to cooperation with PowerSecurity.	19
5.3.4 Setting the transmission speed „trS”   applies to cooperation with PowerSecurity.	20
5.3.5 Setting the parity of the transmission “trP”   applies to cooperation with PowerSecurity.	21
5.4 ACOUSTIC INDICATION.	21
5.5 TECHNICAL OUTPUTS.	22
5.6 INPUT OF COLLECTIVE FAILURE EXT IN.	22
5.7 ENCLOSURE TAMPER INDICATION - TAMPER.	23
5.8 OVERVOLTAGE PROTECTION OF THE PSU OUTPUT OVP.	24
5.9 PSU OVERLOAD.	24
6 RESERVE POWER SUPPLY CIRCUIT.	25
6.1 RUNNING THE PSU FROM THE BATTERY.	25
6.2 DEEP DISCHARGE BATTERY PROTECTION UVP.	25
6.3 BATTERY TEST.	25
6.4 STANDBY TIME.	26
6.5 BATTERY CHARGING TIME.	26
6.6 OPERATION WITHOUT A BATTERY.	26
7. REMOTE MONITORING (OPTIONS: ETHERNET, RS485).	27
7.1 ETHERNET NETWORK COMMUNICATION.	27
7.2 „POWERSECURITY” PROGRAM.	29

8. TECHNICAL PARAMETERS	30
TABLE 13. ELECTRICAL PARAMETERS.....	30
TABLE 14. MECHANICAL PARAMETERS.....	31
TABLE 15. SAFETY OF USE	31
9. TECHNICAL INSPECTIONS AND MAINTENANCE	32

1. PSU features.

- EN50131-6 compliance, 1÷3 grades and II environmental class
- mains supply of ~230 V
- uninterrupted voltage of 13,8 V DC
- fitting battery: 65 Ah/12 V
- high efficiency 80%
- PSU current efficiency:
 - 5,41 A – for grades 1 , 2 *
 - 2,16 A – for grades 3 **
 - 10 A – for general use ***(see: chapter 3.1)
- low level of voltage ripple
- microprocessor-based automation system
- intelligent management of PSU's output power level
- 'SERIAL' communication port with implemented MODBUS RTU protocol
- remote monitoring (option: Ethernet, RS485)
- free program - 'PowerSecurity' for monitoring the PSU operation parameters
- load current control
- output voltage control
- output fuse status control
- dynamic battery test
- battery circuit continuity control
- battery voltages control
- battery fuse status control
- battery charge and maintenance control
- deep discharge battery protection (UVP)
- battery overcharge protection
- battery output protection against short circuit and reverse polarity connection
- jumper selectable battery charging current
0,6 A/1,5 A/2,2 A/3 A
- remote battery test (additional module required)
- START button for battery activation
- STOP button for disconnecting during battery-assisted operation
- optical indication – LED panel
 - output current readings
 - output voltage readings
 - failure codes with history
- optical indication of PSU overload OVL
- acoustic indication of failure
- adjustable times indicating AC power failure
- technical inputs/outputs with galvanic isolation
- EXT IN input of collective failure
- EPS technical output indicating AC power loss
- PSU technical output indicating PSU failure
- APS technical output indicating battery failure
- internal memory of PSU operating status
- protections:
 - SCP short circuit protection
 - OLP overload protection
 - OHP overheat protection
 - OVP over voltage protection
 - surge protection
 - against tampering: unwanted opening of the enclosure or detachment from the mounting surface
- convectional cooling
- warranty – 5 year from the production date

2. Functional requirements of the PSU compliant with the EN 50131-6 standard.

Functional requirements	Requirements of EN 50131-6			PSBEN10A12E
	Grade 1	Grade 2	Grade 3	
EPS network absence	YES	YES	YES	YES
Low battery voltage	YES	YES	YES	YES
Protection against complete battery discharge	-	-	YES	YES
Battery failure	-	-	YES	YES
No battery charge	-	-	YES	YES
Low output voltage	-	-	YES	YES
High output voltage	-	-	YES	YES
PSU failure	-	-	YES	YES
Surge protection	-	-	YES	YES
Short circuit protection	YES	YES	YES	YES
Overload protection	YES	YES	YES	YES
Output fuse activation	-	-	-	YES
Battery fuse failure	-	-	-	YES
EPS technical output	YES	YES	YES	YES
APS technical output	YES	YES	YES	YES
PSU technical output	YES	YES	YES	YES
Input of collective failure	-	-	-	YES
Remote battery test	-	-	-	YES
Tamper indicating enclosure opening	YES	YES	YES	YES
Tamper indicating detachment from the mounting surface	-	-	YES	YES

3. Technical description.

3.1 General description.

The buffer power supply is designed in accordance with the requirements of the EN 50131-6 standard, grade 1-3 and II environmental class. It is intended for an uninterrupted supply of alarm system devices requiring stabilized voltage of 12 V DC (+/-15%).

Depending on a required protection level of the alarm system in the installation place, the PSU efficiency and the battery charging current should be set as follows:

* Grade 1, 2 - standby time 12h

Output current 5,41 A + 3 A battery charge

** Grade 3 - standby time 30h if the faults of the main power source are reported to the Alarm Receiving Centre - ARC (in accordance with 9.2 – EN 50131-1 standard).

Output current 2,16 A + 3 A battery charge

- standby time 60h if the faults of the main power source are reported to the Alarm Receiving Centre - ARC (in accordance with 9.2 – EN 50131-1 standard).

Output current 1,08 A + 3 A battery charge

*** General use – if the PSU is not mounted in an installation compliant with the EN-50131 standard, the acceptable current efficiency amounts to:

1. Output current 10 A + 0,6 A battery charge

2. Output current 9,1 A + 1,5 A battery charge

3. Output current 8,4 A + 2,2 A battery charge

4. Output current 7,6 A + 3 A battery charge

Total current of the receivers + battery: 10,6 A max.

In case of power decay, a battery back-up is activated immediately. The PSU is housed in a metal enclosure (color: RAL 9005 - black) with battery space for a 65 Ah/12 V battery. It is fitted with micro switches indicating unwanted door opening (front panel) and detachment from the mounting surface.

DOPTIONAL POWER SUPPLY CONFIGURATIONS:

(visualization available at www.pulsar.pl)

- 1. Buffer power supply PSBEN 13,8 V/8x1 A/65 Ah/INTERFACE**
- PSBEN 10A12E + LB8 8x1 A (AWZ579, AWZ580)+65 Ah+INTERFACE
- 2. Buffer power supply PSBEN 13,8 V/2x12 V/2x5 A/65 Ah**
- PSBEN 10A12E + 2xRN500 (13,8 V/12 V)+65 Ah

3.2 Block diagram.

The PSU is manufactured based on a high-duty system of DC/DC converter. The microprocessor system is responsible for full diagnostics of the PSU and battery parameters.

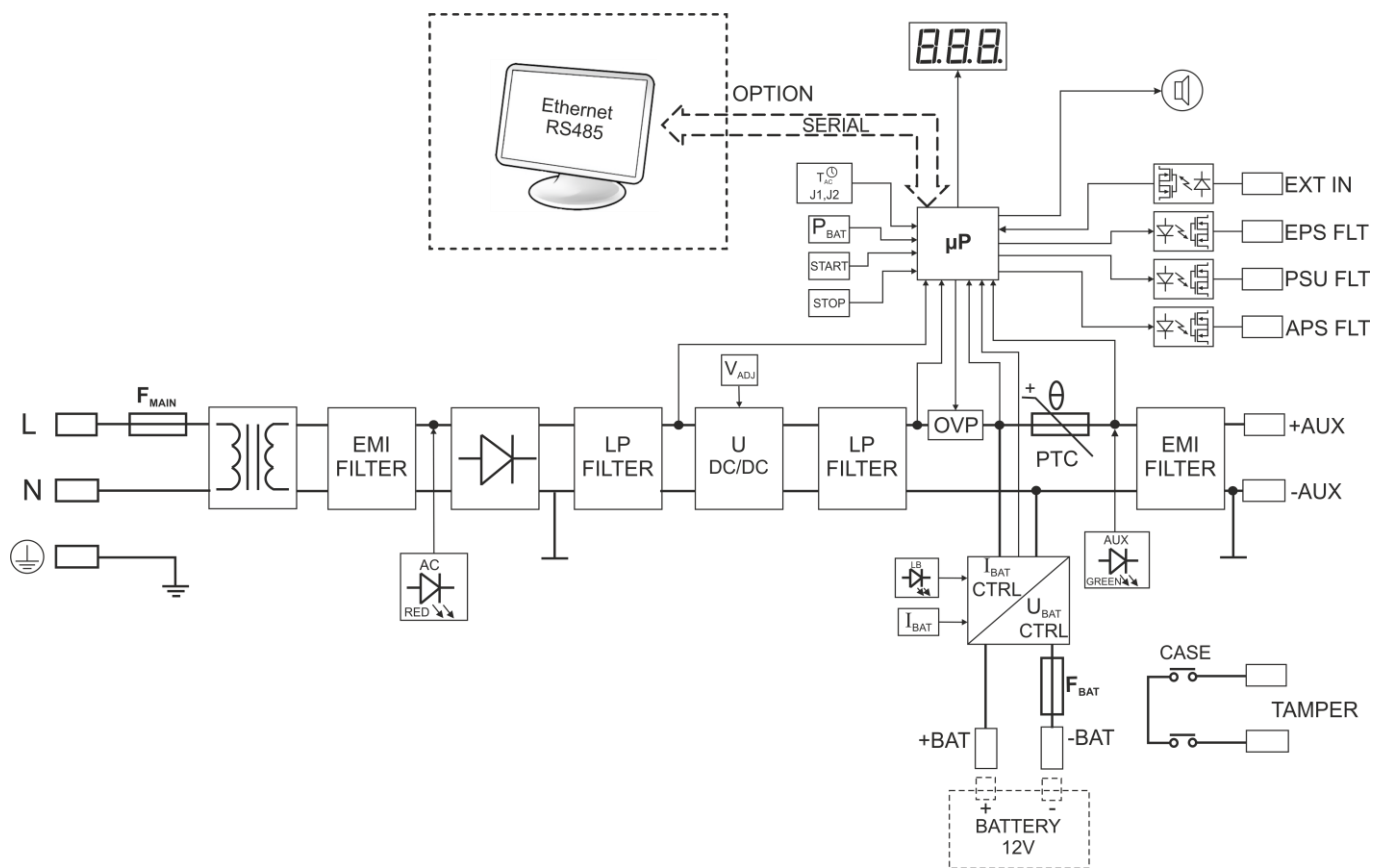











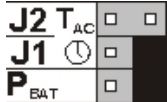
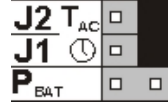



















Fig. 1. Block diagram of the PSU.

3.3 Description of PSU's components and connectors.

Table 1. Elements of the PSU pcb (see Fig. 2).

Element no.	Description
①	PANEL – optical indication connector
②	<p>P_{BAT}; pin - configuration of battery protection UVP</p> <ul style="list-style-type: none"> • P_{BAT} =  battery protection (disconnection) off • P_{BAT} =  battery protection (disconnection) on <p>T_{AC}; pins J1, J2 - adjustable time lag of AC power failure indication</p> <ul style="list-style-type: none"> • J1= , J2=  time lag T= 5s • J1= , J2=  time lag T= 140s • J1= , J2=  time lag T= 17m • J1= , J2=  time lag T= 2h 20m <p style="text-align: right;">Caption:  jumper on,  jumper off</p> <p>Operation without battery (section 6.6)</p>  <p>Disabling the time-based lock of the test. (section 6.3)</p> 
③	<p>I_{BAT} – pin; battery charging current selection</p> <p>J1= , J2=  J3=  I_{BAT} =0,6 A</p> <p>J1= , J2=  J3=  I_{BAT} =1,5 A</p> <p>J1= , J2=  J3=  I_{BAT} =2,2 A</p> <p>J1= , J2=  J3=  I_{BAT} =3 A</p> <p style="text-align: right;">Caption:  jumper on,  jumper off</p>
④	<p>START – button (launching the PSU from a battery)</p> <p>STOP – button (disconnection of the PSU during battery-assisted operation)</p>
⑤	<p>•)) – pin; activation of the acoustic indication</p> <p> - indication on</p> <p> - indication off</p> <p style="text-align: right;">Caption:  jumper on,  jumper off</p>
⑥	V_{ADJ} – potentiometer, DC voltage adjustment
⑦	BUZZER – acoustic indicator
⑧	F_{BAT} – fuse in the battery circuit
⑨	<p>Connectors:</p> <p>~AC~ – AC power input</p> <p>+BAT – DC power battery output</p> <p>+AUX – DC power output (+AUX= +U, -AUX=GND)</p> <p>EPS FLT – technical output of AC network absence indication</p> <p style="padding-left: 20px;">open = AC power failure</p> <p style="padding-left: 20px;">close = AC power - O.K.</p> <p>PSU FLT – technical output of PSU failure</p> <p style="padding-left: 20px;">open = failure</p> <p style="padding-left: 20px;">close = PSU working correctly - O.K.</p> <p>APS FLT – technical output of battery failure</p> <p style="padding-left: 20px;">open = battery failure</p> <p style="padding-left: 20px;">close = battery O.K.</p> <p>EXT IN – input of collective failure</p>
⑩	V_{EXT} pin – polarization of EXT IN circuit
⑪	Communication connector
⑫	<p>LEDs – optical indication:</p> <p>AC – presence of the AC power</p> <p>AUX – DC output voltage</p> <p>OVL – PSU overload</p> <p>PSU – PSU failure</p> <p>APS – battery failure</p> <p>EXT – EXT IN input's status</p> <p>LB – battery charge</p>
⑬	OVP – optical indication for activating the over voltage system
⑭	TAMPER – connector for the micro switch tamper

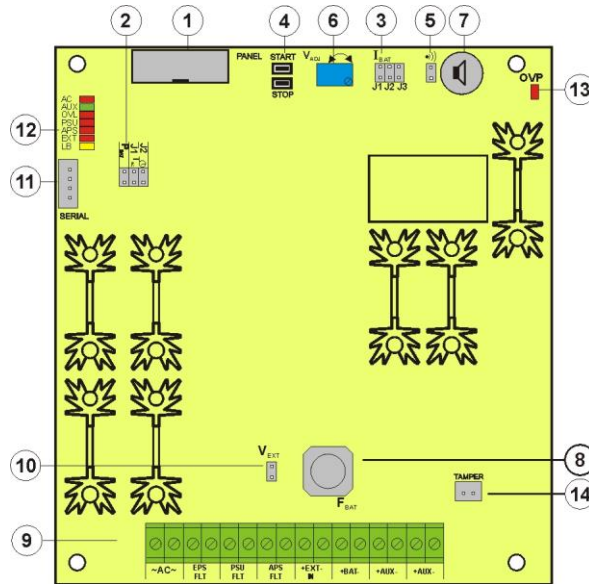

Fig. 2. The view of the PSU's PCB.

Table 2. PSU elements (see fig. 3).

Element no.	Description
①	Insolation transformer
②	PSU board (see Tab.1, fig.2)
③	TAMPER ; micro-switch (contacts) of tamper resistance (NC)
④	F_{MAINS} fuse in the supply circuit (~230 V)
⑤	L-N power supply connector ~230 V, protective connector
⑥	Battery connectors: positive: +BAT = red, negative: - BAT = black
⑦	Tamper grip

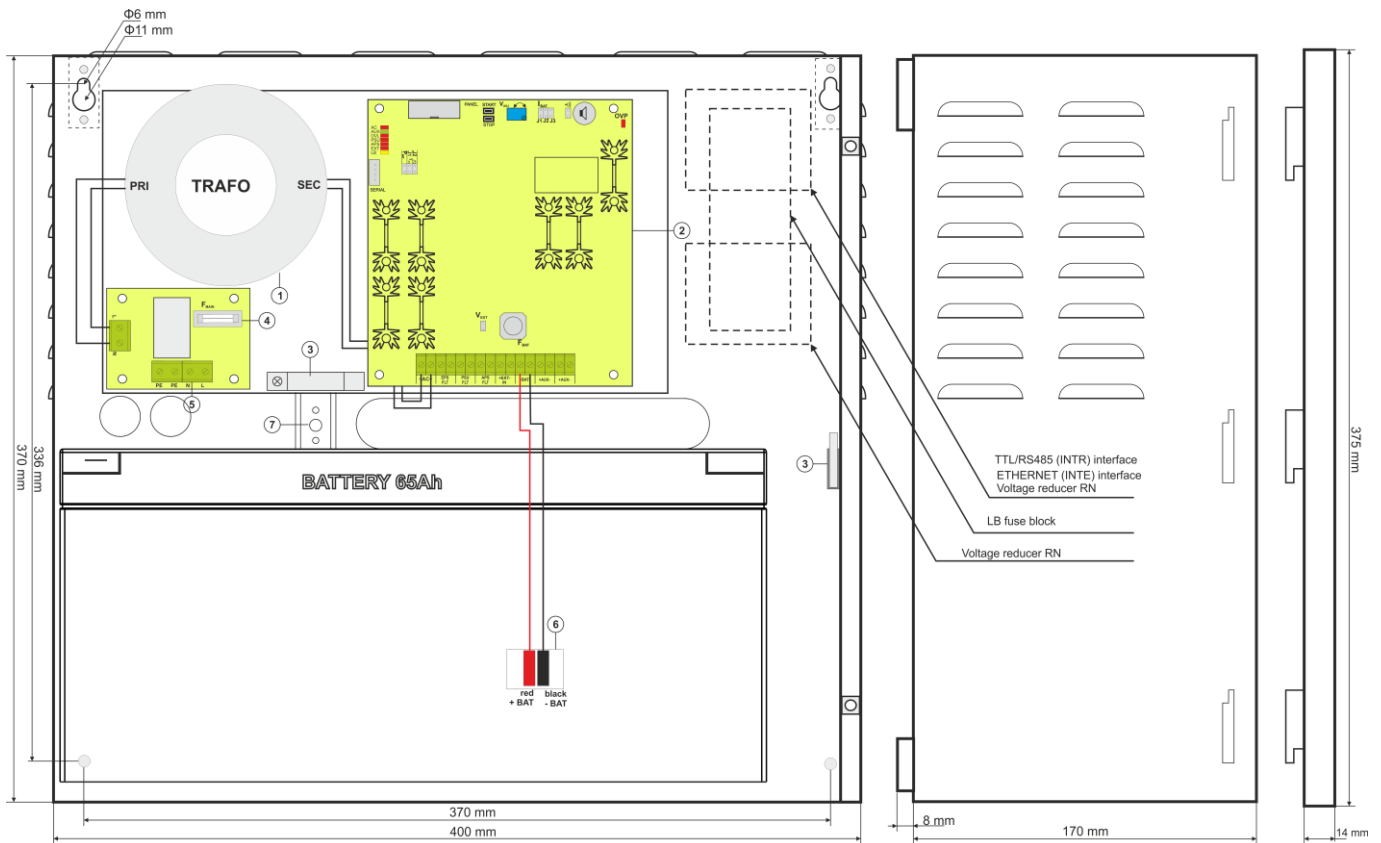

Fig.3. The view of the PSU.

4. Installation.

4.1 Requirements.

The PSU is to be mounted by a qualified installer, holding relevant permits and licenses (applicable and required for a given country) for $\sim 230\text{ V}$ in and low-voltage installations.

As the power supply is designed for a continuous operation and is not equipped with a power-switch, therefore, an appropriate overload protection in the power supply circuit should be provided. Moreover, the user should be informed how to disconnect the power supply unit from the mains supply (usually by assigning an appropriate fuse in the fuse box). The electrical system shall be made in accordance with applicable standards and regulations. The power supply should operate in a vertical position in order to provide free and convectional air flow through ventilating holes of the casing.

4.2 Installation procedure.



CAUTION!

Before installation, cut off the voltage in the $\sim 230\text{ V}$ power-supply circuit. To switch off power use an external switch in which the distance between the contacts of all poles in the disconnection state is not less than 3mm.

It is required to install an installation switch with a nominal current of min. 3 A in the power supply circuits outside the power supply unit.

1. Mount the PSU in a selected location. It is particularly important to bolt the tamper grip to the mounting surface. The grip is located in the central part of the enclosure (see fig. 3 [7]) and guarantees indication in case of any attempts of detaching the device from the mounting surface. Proper installation is one of the requirements of the EN 50131-6 standard.

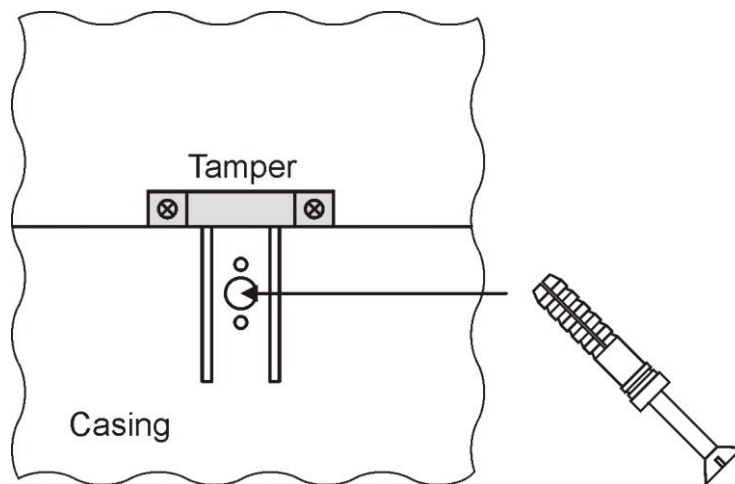

Fig. 4. Fixing a tamper grip.

2. Connect the power cables ($\sim 230\text{ V}$) to L-N terminals of the PSU. Connect the ground wire to the terminal marked by the earth symbol: \oplus . Use a three-core cable (with a yellow and green protection wire) to make the connection. Lead the cables to the appropriate terminals through the insulating bushing.



The shock protection circuit shall be performed with a particular care, i.e. the yellow and green wire coat of the power cable shall stick to one side of the terminal - marked with the grounding symbol \oplus on the PSU enclosure. Operation of the PSU without the properly made and fully operational shock protection circuit is UNACCEPTABLE! It can cause a device failure or an electric shock.

3. Connect the receivers' cables to the +AUX, -AUX connectors of the terminal block on the PSU board.

4. If necessary, connect the device's leads to the technical inputs and outputs:

- EPS FLT; technical output of AC power loss indication (alarm panel, controller, indicator, etc.)
- PSU FLT; technical output of the PSU failure.
- APS FLT; technical output of the battery failure.
- TAMPER; output indicating enclosure opening or detachment from the assembly surface.
- EXT IN; input of collective failure.

5. With the I_{BAT} jumper determine the maximum battery charging current, in accordance with the battery parameters.

6. With the P_{BAT} jumper determine if the discharged battery disconnection system $U < 10\text{ V}$ (+/-5%) shall be on or

off. **The battery protection is on when the P_{BAT} jumper is off.**

7. Switch on the ~230 V supply (red AC diode and green AUX diode should be on).
8. Check the output voltage (the PSU voltage without load and without battery should amount to 13.7 V ÷ 13.9 V, with a battery or during battery charging process: 11.0 V ÷ 13.8 V). If the value of the voltage requires adjustment, it should be set with use of the V_{ADJ} potentiometer, monitoring the voltage at the AUX output of the PSU.
9. Connect the batteries in accordance with the markings: +BAT red to 'plus', -BAT black to 'minus'. The LB diode should be on during battery charging process.
10. Press the STOP button to activate or deactivate a dynamic battery test. Deactivating the test turns out the PSU failure indication at the APS FLT output, but it does not affect the protection system against complete battery discharge.
11. Check the current consumption of the receivers, taking into account the battery charging current, so as not to exceed the total current efficiency of the PSU.
12. Once the tests are completed, close the PSU cover.

Table 3. Operation parameters.

Environmental class	II
Operating temperature	-10°C...+40°C
Storing temperature	-20°C...+60°C
Relative humidity	20%...90%, no condensation
Sinusoidal vibrations during operation	EN 50130-5
Surges during operation	EN 50130-5
Direct insolation	unacceptable
Vibrations and surges during transport	PN-83/T-42106

Table 4. Factory settings of the PSU.

Indication time of EPS network loss	5s	section 5.5
Battery charging current	1,5 A	section 6.5
Battery presence	YES (battery present)	section 6.6
Battery test	ON	section 5.3.1 section 6.3
Deep discharge battery protection UVP	ON	section 6.2
Acoustic indication	ON	section 5.4
LED display dimmer	OFF	section 5.3.2
Communication address	1	section 5.3.3
Transmission	115.2k 8E1	section 5.3.4 section 5.3.5

5. Functions.







5.1 Control Panel.

The PSU features a panel with buttons and LED display, enabling reading of all the available electrical parameters. The panel buttons are used to select and confirm the parameters, which should be displayed.



Fig. 5. Control panel.

Table 5. The description of the buttons and LEDs of the LED panel.

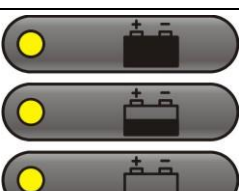
	Description	Additional information
	- moves the pointer on the screen - next screen selection	
	- selection approval	
	- red LED – indicating ~230 V voltage	
	- red LED – indicating power supply overload	section 5.9
	- red LED – indicating PSU failure	section 5.2.5
	- red LED – indicating battery failure	
	- green LED – indicating power at the AUX output of the PSU	
	- three yellow LEDs indicating approximate battery charge level	

5.2 Main menu.

The PSU is equipped with a menu, which allows to preview the current electrical parameters. The diagram explaining the menu structure is presented below.

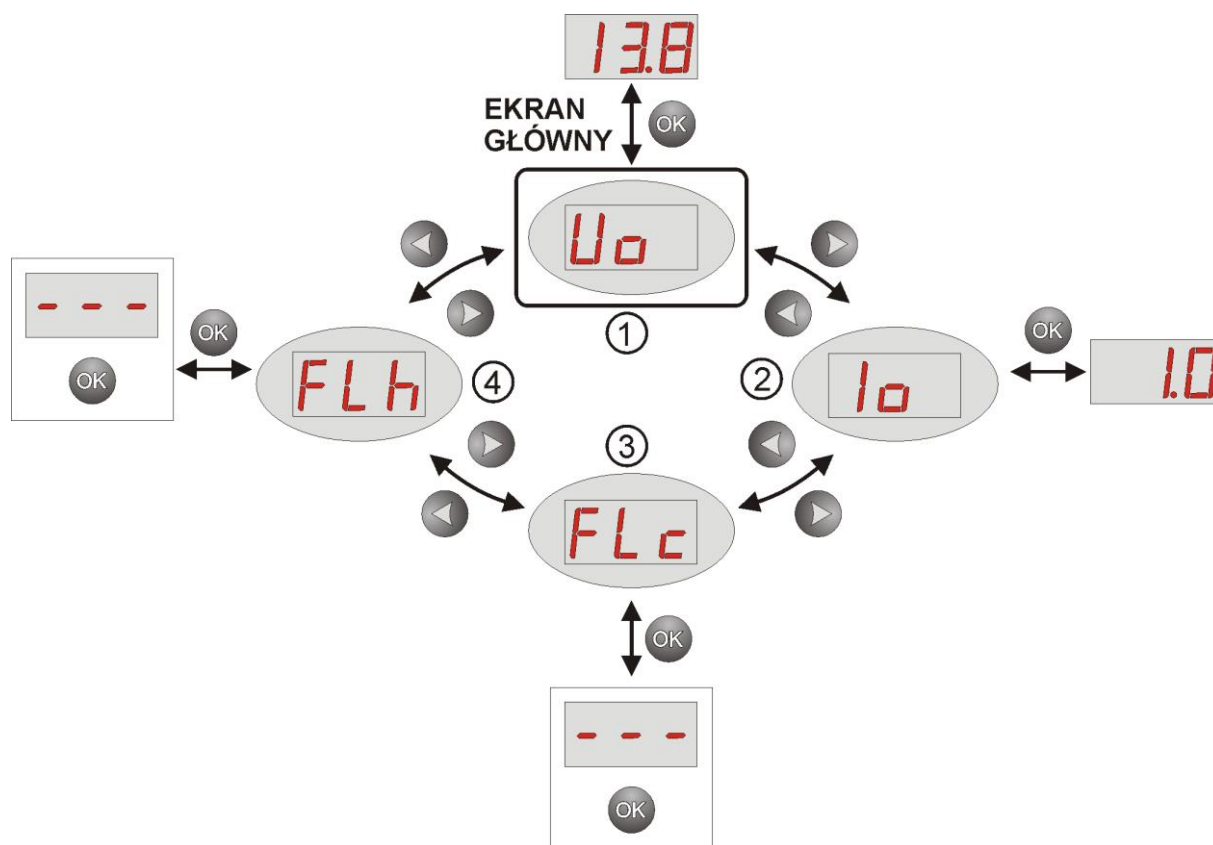

Fig. 6. The menu of the display.

Table 6. The description of display symbols.

	Symbol	Description	Additional information
①	Uo	AUX output voltage [V]	Factory setting 13,8 V
②	Io	Output current [A]	
③	FLh	Failure history	Section 5.2.3
④	FLc	Current failures	Section 5.2.4

5.2.1 Voltage indicator „Uo”



The voltage indicator displays the measured output voltage at the AUX output. If the voltage drops below 13 V (during operation with activated battery test) or exceeds 14.7 V, the PSU will indicate a failure.

The resolution of voltage measurement is 0.1 V and should be treated with caution. If a greater accuracy is required, use a multimeter.

5.2.2 Output current indicator „Io”



The output current indicator displays the measured output current drawn from the AUX output.

If the current value is exceeded, the power supply unit will indicate failure.

The resolution of current measurement is 0.1 A and should be treated with caution. If a greater accuracy is required, use a multimeter.

5.2.3 Failure history "FLh" **FLh**

The PSU stores 30 last failures in non-volatile memory, which can be reviewed later. In order to review the failures, use the "<" or ">" button to set the **FLh** parameter and confirm by pressing "OK". The display will show the number of failure in the memory and its code. Pressing the "OK" button again will display the next failure in the memory.



The memory of the new power supply remembers the events that are the result of the efficiency tests carried out at the production stage.

- press „<” or „>” button to set the „FLh” parameter on the display

- press „OK” button

- number 1, indicating the number of failure in the memory (the highest priority), will be displayed. Then, after one second, failure code will be automatically displayed

- press „OK” button

- the number 2, denoting the next number of failure in the memory, will be displayed. Then, after one second, the next failure code will be automatically displayed.

- if the memory has more failures, pressing the "OK" button will result in displaying subsequent codes

- the „- - -” parameter on the display marks the end of the list of failures

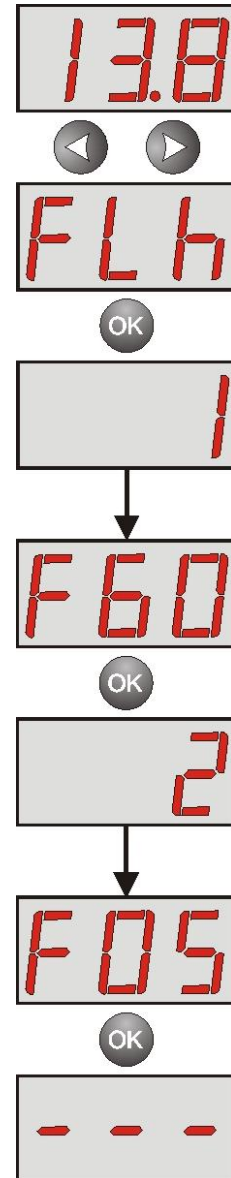

5.2.4 Current failures „FLc” **FLc**

In case of abnormal electrical parameters, the power supply provides optical and acoustic indication of the failure via corresponding LED and a beeper (if not disabled).

The PSU can simultaneously indicate several failures. Thanks to this solution, codes of all failures and their priority can be previewed in the **FLc** menu. In the **FLc** menu, each press of the "OK" button on the panel displays the next error code that caused the failure. If there are multiple failures at the same time, pressing the "OK" button will display the next code. The display order of failures is arranged by priority of importance. The first failures in the display order are of the highest priority.

Section 5.2.5 summarizes all the failure codes that may occur during the power supply operation. The individual codes are accompanied by appropriate optical indication on the panel, acoustic indication and activation of the dedicated technical output.

- press „<” or „>” button to set the „FLc” parameter on the display „FLc”



- press „OK” button



- the number 1, indicating the number of failure in the memory (the highest priority), will be displayed. Then, after one second, failure code will be automatically displayed



- press „OK” button



- the number 2, denoting the next number of failure in the memory, will be displayed. Then, after one second, the next failure code will be automatically displayed.



- if the memory has more failures, pressing the "OK" button will result in displaying subsequent codes



- the „- - -” parameter on the display marks the end of the list of failures

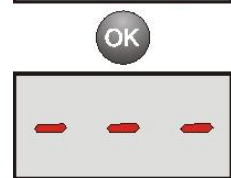

5.2.5 List of failure codes and information messages.

The PSU indicates the operation status with the appropriate code. The codes are divided into two groups, marked with the initial letters "F" or "I".

The codes beginning with the letter "F" indicate a failure. The codes that begin with the letter "I" indicate the correct operation of the PSU or repaired fault, involving, for example, fuse replacement: "I03 - BAT fuse replaced".

Table 7. List of PSU failure codes.

Failure code	Information	Technical output activation	Additional information	Additional information
F01	AC power fail!	EPS FLT	- No AC mains supply - F _{MAINS} fuse failure	
F02	AUX fuse fail!	PSU FLT	- Blown F _{AUX} fuse - AUX output overload	
F03	BAT fuse fail!	APS FLT	- Blown F _{BAT} fuse - Short circuit in the battery circuit - Short circuit in the AUX output circuit	
F04	Output overload!	PSU FLT	- PSU overload	Section 5.9
F05	Battery fail!	APS FLT	- Worn out battery - Undercharged battery - Battery not connected	Section 5.5 Section 6
F06	High AUX voltage!	PSU FLT	- Output voltage over 14.7 V	
F07	High battery voltage!	PSU FLT	- Battery voltage >14 V	
F08	Charge circuit fail!	PSU FLT	- The output voltage of the PSU set too low, below 13 V - Battery charging circuit failure	
F09	Low AUX voltage!	PSU FLT	- Output voltage below 11,8 V (during buffer operation)	
F10	Low battery voltage!	APS FLT	- the battery voltage has dropped below 11,5 V (during battery-assisted operation)	
F11	Low battery volt. – off!	APS FLT	- the battery voltage has dropped below 10 V (during battery-assisted operation)	
F12	External input EXTi!		- Activation of the input of collective failure EXT IN	Section 5.6
F13	PSU cover opened!	PSU FLT		
F50-F54	Internal supply fail!	PSU FLT	- service codes	
F60	No communication	PSU FLT	- no communication with LCD panel	
F61-F64	Control panel fail	PSU FLT	- service codes	
F65	Access unlocked		- passwords unlocked	

Table 8. List of PSU message codes.

Message code	Description
I00	Power supply start-up
I01	AC power back
I02	AUX fuse replaced
I03	BAT fuse replaced
I04	Battery OK
I05	Battery test – START
I06	PSU cover closed

Table 9. Optical indication of failure with the PSU LED on the PCB of the PSU.

The number of flashes of the PSU LED on the PCB of the power supply	Failure code	Failure description
1	F06	High AUX voltage!
2	F07	High battery voltage!
3	F08	Charge circuit fail!
4	F09	Low AUX voltage!
5	F50-F54 F60	Internal supply fail! No communication
6	F13	PSU cover opened!

5.3 PSU configuration.

The PSU is equipped with a configuration menu that allows to configure the settings by changing or the activation of some of its parameters. The figure illustrating the configuration menu structure is shown below.

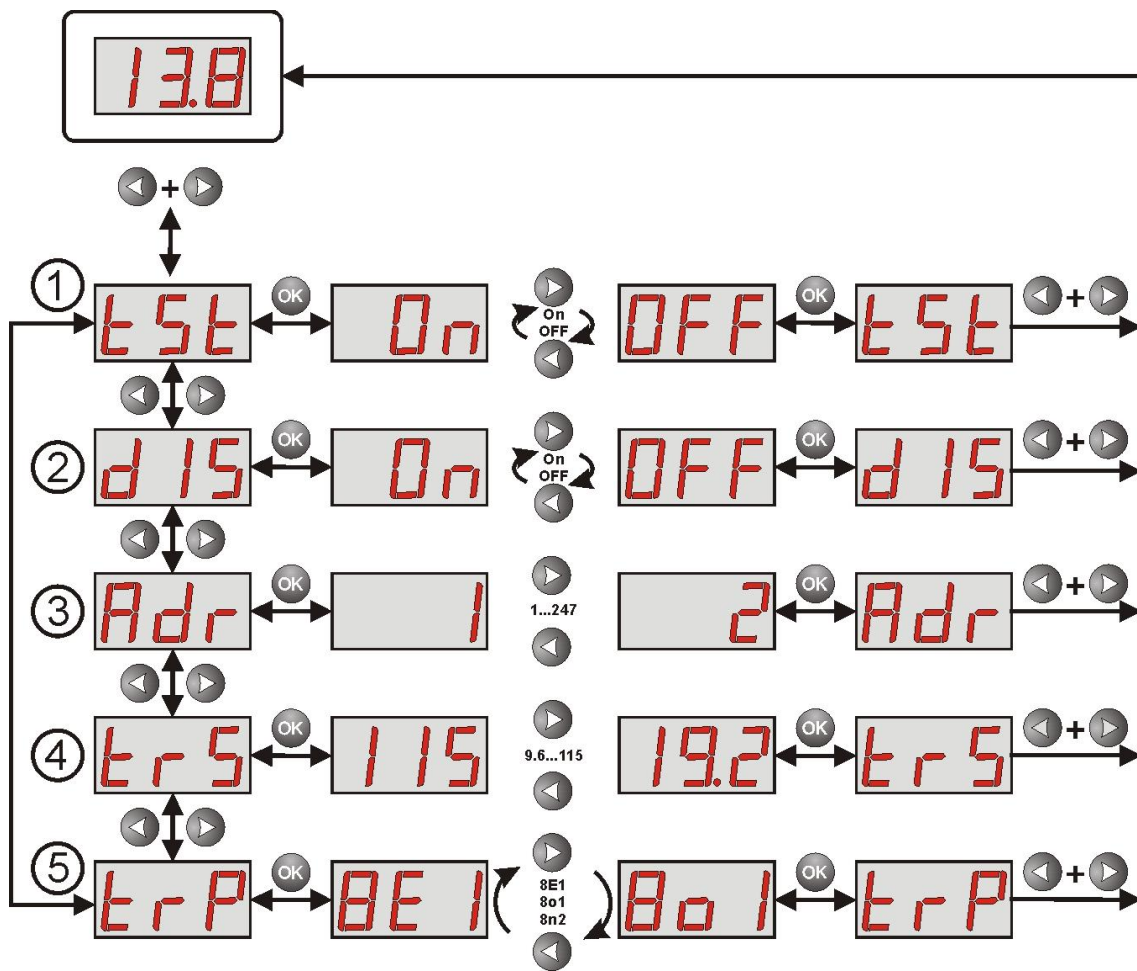

Fig. 7. The PSU configuration menu.

Table 10. Description of symbols.

	Symbol	Description	Additional information
①	tSt	Battery test – „tSt” On – battery test on OFF – battery test off	Sections 5.3.1
②	d15	LED display dimmer On – dimmer ON OFF – dimmer OFF	Sections 5.3.2
③	Adr	Communication address – „Adr” 1÷ 247 power supply address required at the time of communication with the computer 1 – factory setting	Sections 5.3.3
④	trS	Transmission – „trS” Determines the speed of communication 9.6k : 115.2k (factory setting)	Sections 5.3.4
⑤	trP	Parity of the transmission – „trP” Determines the method of communication 8N2 8E1 (factory setting) 8O1	Sections 5.3.5

5.3.1 Battery test ON/OFF „tSt”

The "tSt" function allows to enable or disable the test of the battery (Section 6.3) connected to the power supply. When activated, the battery test occurs automatically if it is not blocked by the control system (section 6.3).

- simultaneously press the „<,>” rightmost and leftmost buttons on the LED panel

- the „tSt” parameter will be displayed

- press „OK”

- the current settings will be displayed

- use the „<” or „>” buttons to in order to set the status

On – battery test on

OFF – battery test off

- approve your choice with the ‘OK’ button

- in order to return to the main menu, simultaneously press the „<,>” rightmost and leftmost buttons on the LED panel





Deactivating/activating the test with the STOP button on the PCB of the PSU.

During mains-powered PSU operation press the STOP button on the main board and hold it for 3 seconds. The device will confirm the activation/deactivation:

- testing off – the tOF sign appears on the display , single beep
- testing on – the tOn sign appears on the display , double beep



Deactivating/activating the test is stored in the memory even after unplugging the device from mains. The battery failure indication at the APS FLT output is automatically switched off. The battery protection system against deep discharged remains on, though.

5.3.2 LED Display Dimmer „dIS” 

LED display dimmer allows to dim the display if no buttons are pressed within 5 minutes. If the display is in the blackout mode, pressing any button will "reactivate" the display.

- simultaneously press the „<,>” rightmost and leftmost buttons on the LED panel
- the „tSt” parameter will be displayed
- use the „<” or „>” buttons to display the „dIS” parameter
- press „OK”
- the current status will be displayed
- use the „<” or „>” buttons in order to set the status
 - On** – dimmer on
 - OFF** – dimmer off
- confirm by pressing „OK”
- in order to return to the main menu, simultaneously press the „<,>” rightmost and leftmost buttons

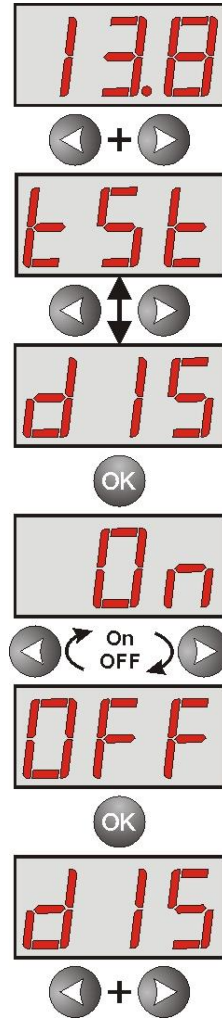

5.3.3 Setting the communication address „Adr”   applies to cooperation with PowerSecurity.



All power supplies are factory-set to address 1.

All the parameters responsible for communication between the PSU and the computer, namely the address, parity and speed should have the same settings for both the PSU and the PowerSecurity program. Communication address allows to identify power supply units in the same communication network.

- simultaneously press the „<,>” rightmost and leftmost buttons
- the „tSt” parameter will be displayed

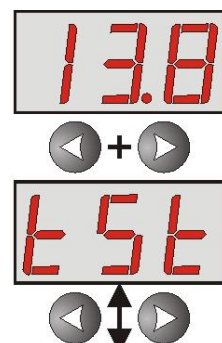

- use the „<” or „>” buttons to display the „Adr” parameter
- press „OK”
- the current address of the PSU will be displayed
- use the „<” or „>” buttons in order to set the address
1 ÷ 247 – address of the PSU during the communication with the computer
- confirm by pressing „OK”
- in order to return to the main menu, simultaneously press the „<,>” rightmost and leftmost buttons

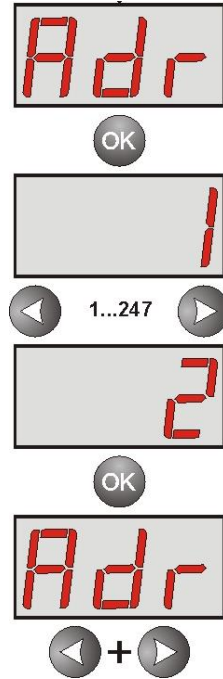

5.3.4 Setting the transmission speed „trS”  **applies to cooperation with PowerSecurity.**

All the parameters responsible for communication between the PSU and the computer, namely the address, parity and speed should have the same settings for both the PSU and the PowerSecurity program.

The PSU has preset transmission parameters of 115200 baud 8E1. However, if it is connected to the network with differently defined parameters, make the appropriate changes to its configuration.

- simultaneously press the „<,>” rightmost and leftmost buttons
- the „tSt” parameter will be displayed
- use the „<” or „>” buttons to display the „trS” parameter
- press „OK”
- the information about the transmission speed will be displayed
- use the „<” or „>” buttons in order to set the required transmission speed,
 - **9.6k**
 - **115.2k** (factory setting)
- confirm by pressing „OK”
- in order to return to the main menu, simultaneously press the „<,>” rightmost and leftmost buttons



5.3.5 Setting the parity of the transmission “trP”  applies to cooperation with PowerSecurity.

All the parameters responsible for communication between the PSU and the computer, namely the address, parity and speed should have the same settings for both the PSU and the PowerSecurity program.

The PSU has preset transmission parameters of 115200 baud 8E1. However, if it is connected to the network with differently defined parameters, make the appropriate changes to its configuration.

- simultaneously press the „<,>” rightmost and leftmost buttons
- the „tSt” parameter will be displayed
- use the „<” or „>” buttons to display the „trP” parameter
- press „OK”
- the information about the parity of the transmission will be displayed on the panel
- use the „<” or „>” buttons in order to set the required communication mode,
 - 8N2
 - 8E1 (factory setting)
 - 8O1
- confirm by pressing „OK”
- in order to return to the main menu, simultaneously press the „<,>” rightmost and leftmost buttons

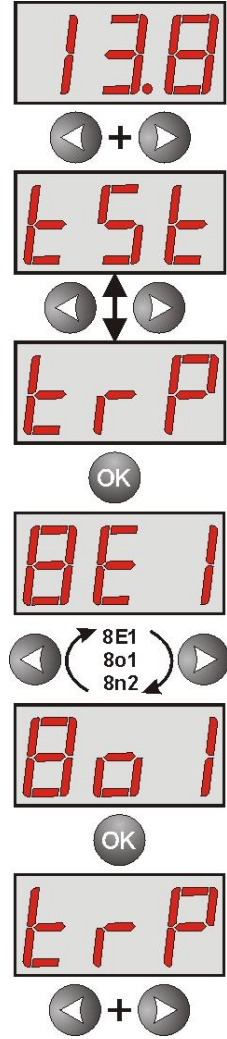

5.4 Acoustic indication.

Emergency situations are acoustically indicated. The frequency and the number of signals depend on an event type (see chapter. 5.2.5). The acoustic indication is off after removing an appropriate jumper (fig. 2, [5]).

Table 11. Acoustic indication.

No.	Description	Event
1	1 signal per 10s, battery-assisted operation	No 230 V supply
2	1 signal per 10s, mains operation	Battery fault, undercharged battery
3	2 signals per 10s, battery-assisted operation	Low level of battery charge
4	Fast signals, battery-assisted operation	The PSU will be disconnected due to the battery discharge
5	Continuous indication	PSU failure [see chapter. 5.2.5]
6	1 signal	Breaking the battery test
7	2 signals	Activation of the battery test

5.5 Technical outputs.

The PSU feature indication outputs, with galvanic isolation, which change their state if any of the following events occur:

- **EPS FLT - output indicating 230 V power loss.**

The output indicates 230 V power loss. Under normal status (with 230 V supply on) the output is closed. In case of power failure, the PSU will switch the output into the open position after a time lag set by the T_{AC} jumpers (J1, J2).

J1= [off], J2= [off] time lag T= 5s

J1= [off], J2= [on] time lag T= 140s

J1= [on], J2= [off] time lag T= 17m

J1= [on], J2= [on] time lag T= 2h 20m

Caption: [on] jumper on, [off] jumper off

- **APS FLT - output indicating battery failure.**

The output indicates a failure in the battery circuit. Under normal status (during correct operation) the output is close. In case of a failure the PSU will switch the output into the open state. Any failures can be triggered by the following events:

- a faulty or undercharged battery
- battery voltage below 11,5 V during battery-assisted operation
- battery fuse failure
- no continuity in the battery circuit

- **PSU FLT - output indicating PSU failure.**

The output indicates the PSU failure. Under normal status (during correct operation) the output is close. In case of a failure the PSU will switch the output into the open state. Any failures can be triggered by the following events:

- low output voltage U_{aux}<11,8 V
- high output voltage U_{aux}>14,7 V
- high battery voltage U_{aku}>14 V (during battery test)
- polymer fuse PTC activation
- exceeding the PSU nominal current
- failure in the battery charging circuit
- activation of the over voltage protection OVP
- enclosure opening - TAMPER
- internal damage of the PSU
- EXT IN input activation

The technical outputs have been implemented with galvanic isolation between the PSU's systems and the attached devices.

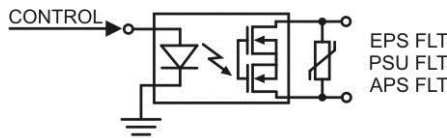

Fig. 8. Electrical diagram of the technical outputs.

5.6 Input of collective failure EXT IN.

The EXT IN (external input) technical input indicating a collective failure is intended for additional, external devices that generate the failure signal. The voltage at the EXT IN input will save information about an incident in the internal memory of the power supply and sending the signal about the failure to the PSU FLT output.

The EXT IN technical input has been implemented with galvanic isolation between the PSU's systems and the devices attached.

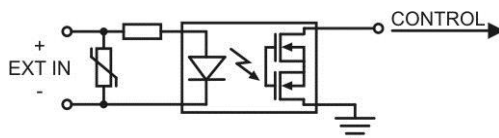

Fig. 9. Electrical diagram of the EXT IN input.

The electrical diagram below shows the way of connecting external devices to the EXT IN input. Outputs such as: OC (open collector), relay may be used as a source of the signal.

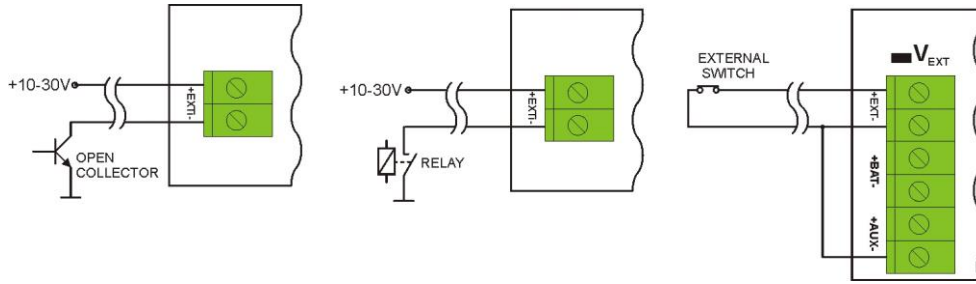

Fig. 10. Examples of connections.

In the option with tamper switches, the V_{EXT} jumper must be on. It polarizes the EXT IN input circuit therefore is required in such configuration.

The EXT IN input has been adjusted to cooperate with fuse modules that generate a failure signal in case of a fuse fault in any of output sections (e.g. AWZ535, AWZ536). To guarantee a correct cooperation between the module and the EXT IN input, the V_{EXT} jumper must be on and the connections are to be made accordingly to the diagram below.

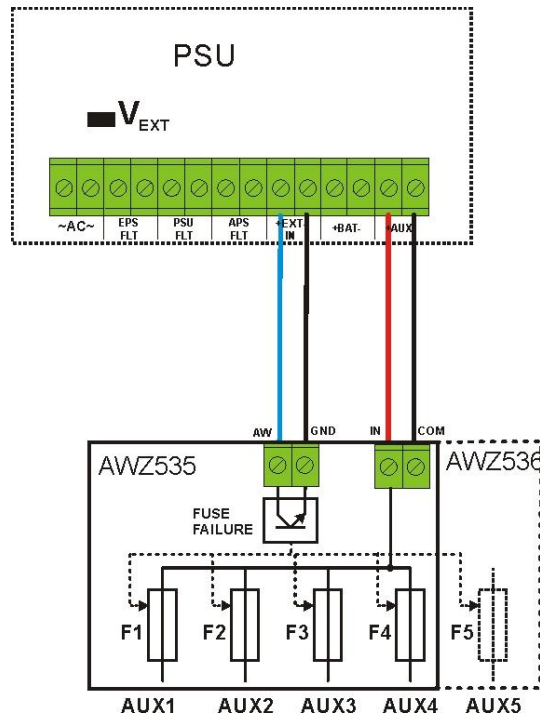

Fig. 11. Example of a connection with the fuse module: AWZ535 or AWZ536.

5.7 Enclosure Tamper Indication - TAMPER.

The PSU is fitted with the micro switch tamper indicating enclosure opening and detaching from the mounting surface.

The tamper cable is not connected to the terminal in the factory settings. In order to activate tamper, remove the jumper from tamper terminal (Fig. 2 [14]) and plug in the tamper cable.

Each opening the enclosure and detaching from the mounting surface will generate a failure signal at the PSU FLT and ALARM technical outputs and will save the event in the internal memory of the PSU.

5.8 Overvoltage protection of the PSU output OVP.

In case of voltage exceeding $15,5 \text{ V} \pm 0.5 \text{ V}$ at the switching regulator's output, the system cuts off the power at the outputs to protect the battery and the receivers from damage. The outputs will be battery-powered. The activation of the protection system is indicated by the OVP yellow LED on the PCB board, and the PSU FLT output.

5.9 PSU overload.

The PSU is fitted with the LED OVL (overload) on the PCB and  indicator on the LED panel, informing about output overload. If the nominal current of the PSU is exceeded, the led turns on and the microprocessor starts a specially implemented procedure. Depending on time and overload level, microprocessor may disconnect the AUX output and switch into the battery-assisted operation. Restart will occur after 1 minute.

PSU overload is indicated by the PSU FLT technical output.

6 Reserve power supply circuit.

The power supply is equipped with intelligent circuits: charging and battery control circuit, whose main task is to monitor the condition of the battery and its connections in the circuit.

If the power supply driver detects a malfunction in the battery circuit, appropriate signaling and change in the APS FLT technical output take place.

6.1 Running the PSU from the battery.

The PSU has been equipped with two buttons on the PCB board which enable running or disconnecting the PSU during battery-assisted operation.

- **Running the PSU from the battery:** press the **START** button on the main board and hold for 1s.
- **Disconnecting the PSU from the battery:** press the **STOP** button on the main board and hold for 5s.

6.2 Deep discharge battery protection UVP.

The PSU is equipped with the disconnection system and the discharged battery indication. If the voltage at the battery terminals drops below $10 V \pm 0.2 V$ will turn on the beep sound and disconnect the battery in the 15 seconds.

Re-connecting the battery to the power supply occurs automatically upon the appearance of the ~230 V mains voltage.

The protection mode is off when the P_{BAT} jumper is removed.



Caution.

Deactivating of the UVP function is not recommended since a deep discharge of the battery limits its capability of storing energy, lowers its capacity and shortens its durability.

6.3 Battery test.

The PSU runs battery test every 5 minutes. During testing, the control unit of the PSU measures the electrical parameters according to the implemented measuring method.

A negative result occurs when the battery circuit continuity is interrupted or if the terminal voltage drops below 12 V.

The battery test can be activated manually (see section 5.3.1), from the menu of the power supply or by pressing the STOP button, for example to test the replaced batteries.

The PSU is protected against too frequent performing of the battery test, which could result in undercharging. The protection involves blocking the ability to perform test for 60 seconds from the last activation.

In such case, the LED will display the „- - „ symbol.

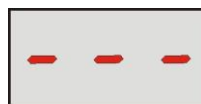

Temporary lock of the battery test can be disabled by putting the J1 jumper between J2 on the power supply board (Fig.2 [2]).

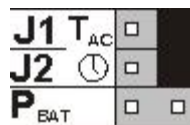

The battery test will also be automatically locked when the PSU is in the operating mode, in which the battery test is impossible. Such condition occurs, for example, during battery assisted operation or when the power supply is overloaded.

6.4 Standby time.

Battery-assisted operating depends on battery capacity, charging level and load current. To maintain an appropriate standby time, current drawn from the PSU in battery mode should be limited. Characteristics for a 65 Ah/12 V SLA:

Grade 1, 2 - standby time 12h

Output current 5,41 A + 3 A battery charge

Grade 3 - standby time 30h if the faults of the main power source are reported to the Alarm Receiving Centre - ARC (in accordance with 9.2 – EN 50131-1).

Output current 2,16 A + 3 A battery charge

- standby time 60h if the faults of the main power source are reported to the Alarm Receiving Centre - ARC (in accordance with 9.2 – EN 50131-1).

Output current 1,08 A + 3 A battery charge

6.5 Battery charging time.

The PSU has a battery circuit charged with direct current. The current selection is done with use of the I_{BAT} jumpers. The table below shows how long does it take to charge a (fully discharged) battery up to min. 80% of its nominal capacity.

Table 12. Battery charging time.

65 Ah battery charging time up to the capacity of 0,8°C	Charging current [A]	Configuration of I_{BAT} jumper
19h30m	3	J1= <input type="checkbox"/> , J2= <input type="checkbox"/> , J3= <input type="checkbox"/>
26h36m	2,2	J1= <input type="checkbox"/> , J2= <input type="checkbox"/> J3= <input checked="" type="checkbox"/>
39h	1,5	J1= <input type="checkbox"/> , J2= <input checked="" type="checkbox"/> J3= <input type="checkbox"/>
-	0,6	J1= <input checked="" type="checkbox"/> , J2= <input type="checkbox"/> J3= <input type="checkbox"/>

6.6 Operation without a battery.

In case of an expected PSU operation without an attached battery, make a necessary configuration of the jumpers:

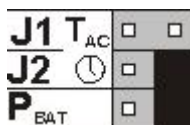

In this mode, the automation system allows adjustments of PSU's output voltage without indicating a failure connected with battery operation.



CAUTION. During operation without battery assistance the PSU does not perform any parameter control that monitors its proper operation. Therefore, this mode ought to be chosen thoughtfully.

7. Remote monitoring (options: Ethernet, RS485).

The PSU has been adjusted to operate in a system that requires a remote control of the parameters in a monitoring centre. Transmitting data concerning PSU status is possible due to an additional, external communication module responsible for communication in Ethernet or RS485 standard.

Different connection topologies, presented later in this chapter, are only a part of possible communication schemes. More examples can be found in the manuals dedicated to individual interfaces.



When installing optional features in the power supply unit, power supply current consumption, used for the calculation of standby time, should be taken into account (see section. 6.4).

7.1 ETHERNET network communication.

Communication in the Ethernet network is possible due to the additional interfaces: Ethernet „INTE” and RS485-ETH „INTRE”, according to the IEEE802.3 standard.

The Ethernet „INTE” interface features full galvanic isolation and protection against surges. It should be mounted inside the enclosure of the PSU.

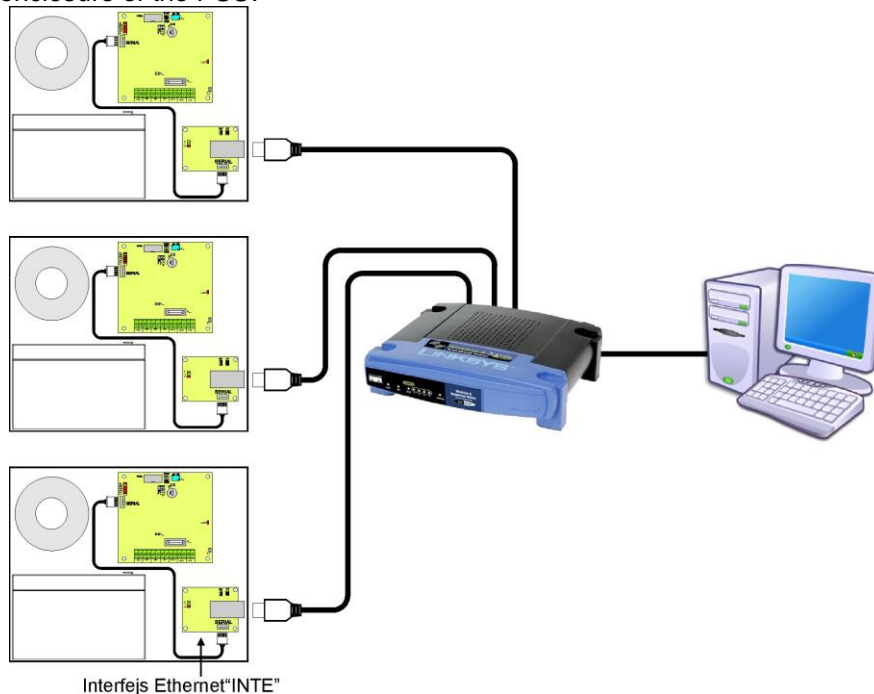

Fig. 12. Ethernet network communication using the Ethernet „INTE” interface.

The RS485-WiFi „INTRE” interface is a device used to convert signals between the RS485 bus and the Wi-Fi network. For proper operation, the unit requires an external power supply in the range of 10÷30 V DC e.g. drawn from a PSU of the PSBEN series. The unit is mounted in a hermetic enclosure protecting against adverse environmental conditions.

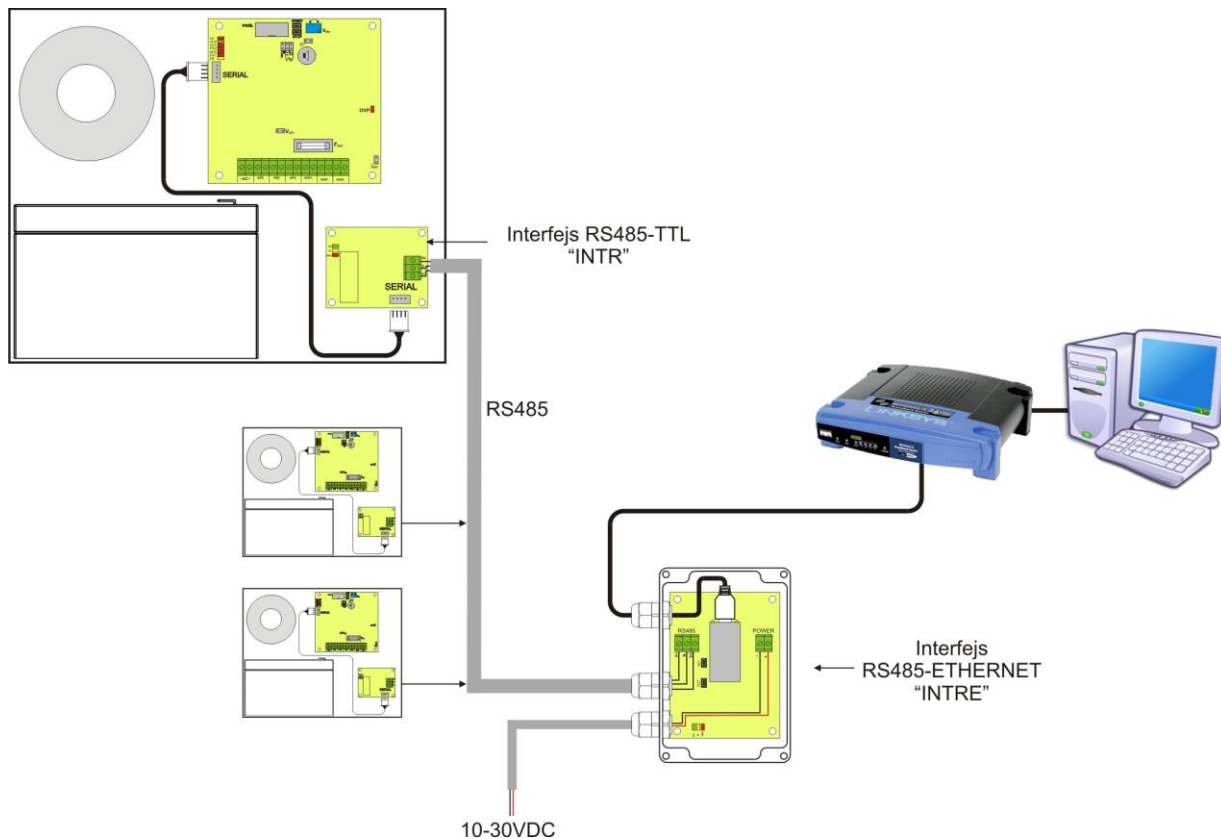

Fig. 13. Ethernet network communication using the RS485 „INTRE” interface.

7.2 „PowerSecurity” program.

The “Power Security” program is available at www.pulsar.pl
Its detailed description can be found in the manual.

„Power Security” is a free computer program for viewing and analyzing the information sent from the PSU installation spots. The main panel is presented below.

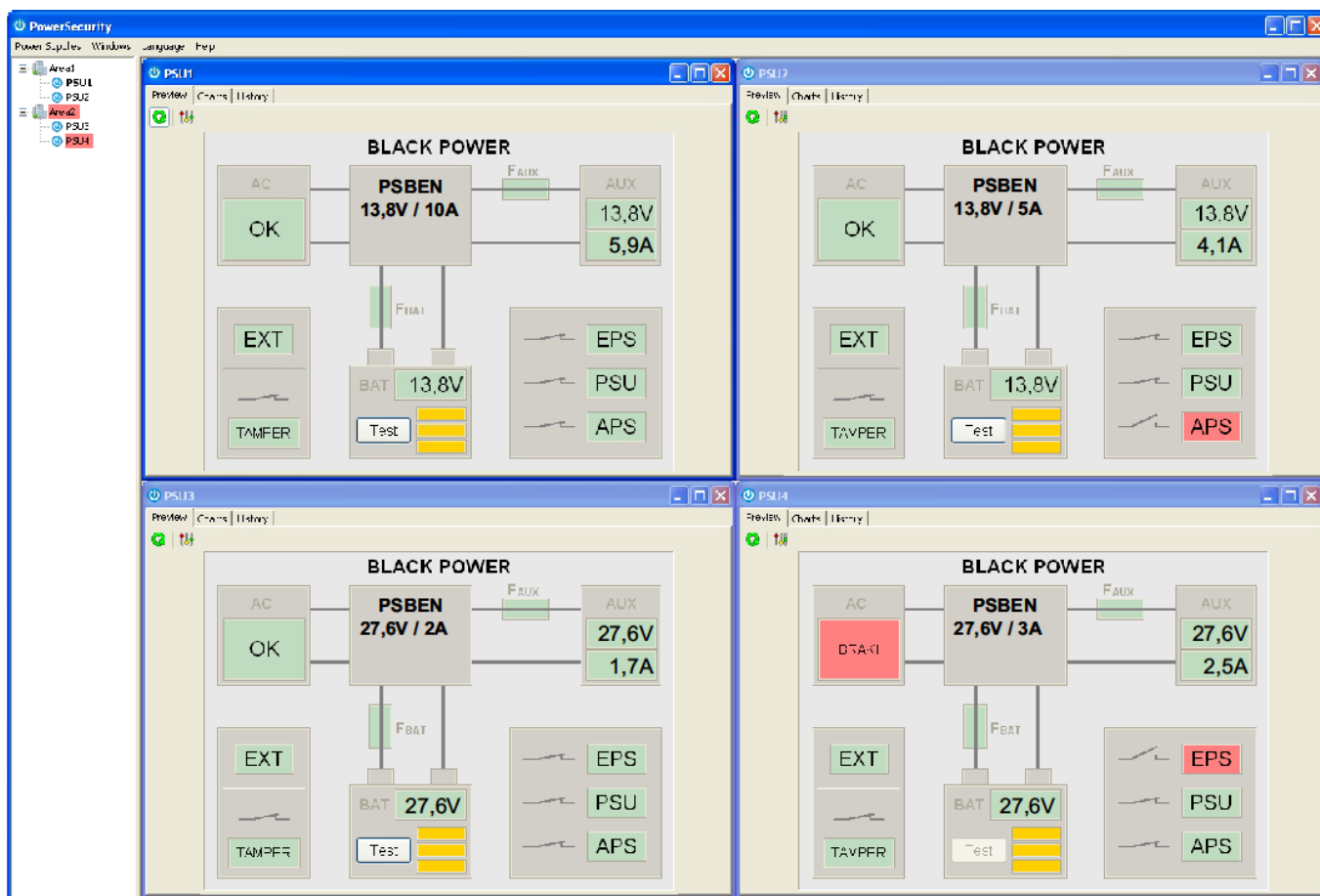

Fig. 14. „Power security” main panel.

It is possible to divide the main panel of the program into smaller areas, depending on the number of monitored power supplies.

The program is equipped with manager mode, which allows the grouping of power supplies for easier analysis and orientation.

The application enables both the visualization and analysis of the received data. Exceeding of the acceptable parameters is indicated by red illumination of the appropriate area or by blinking of the indicator light. Individual tabs allow monitoring the power supply parameters on the chart and failure memory along with the information about the status of technical outputs and electrical parameters.

8. Technical parameters.

Electrical parameters (Table 13).

Mechanical parameters (Table 14).

Safety of use (Table 15).

Table 13. Electrical parameters.

PSU type	A, protection class 1÷3, II environmental class
Mains supply	~230 V; 50 Hz
Current consumption	1,1 A
PSU's power	146 W
Efficiency	80%
Output voltage	11 V± 13,8 V DC – buffer operation 10 V± 13,8 V DC – battery-assisted operation
Output current	- for grades 1, 2: Io = 5,41 A + 3 A battery charging - for grade 3: Io = 2,16 A + 3 A battery charging - (connection with ARC required, compliant with 9.2 – EN 50131-1) Io = 1,08 A + 3 A battery charging - for general use: Io = 10 A + 0,6 A battery charging Io = 9,1 A + 1,5 A battery charging Io = 8,4 A + 2,2 A battery charging Io = 7,6 A + 3 A battery charging
Output voltage adjustment range	12 V± 14,5 V
Ripple voltage	120 mV p-p max.
Current consumption by the PSU systems during battery-assisted operation	I = 22 mA
Battery charging current	0,6 A/1,5 A/2,2 A/3 A – I _{BAT} jumper selectable
Low battery voltage indication	U _{BAT} < 11,5 V, during battery-assisted operation
Surge protection	varistors
Over voltage protection OVP	U > 15,5 V, disconnection of the output voltage (AUX+ disconnection), automatic return
Short circuit protection SCP	Electronic – current limitation and / or F _{BAT} fuse failure in the battery circuit (requires fuse replacement) Automatic return
Overload protection OLP	Program - equipment
Battery circuit protection SCP and reverse polarity connection	T10 A- current limiting, F _{BAT} fuse (failure requires fuse-element replacement)
Deep discharge battery protection UVP	U < 10 V (± 2%) – disconnection (-BAT) of the battery, configuration with jumper P _{BAT}
Indication of opening the cover of the power supply or detachment from the ground	Micro switch TAMPER
Technical outputs: - EPS FLT; output indicating AC power failure	- type – electronic, max 50mA/30 V DC, galvanic isolation 1500 V _{RMS} - time lag, approx. 5s/140s/17m/2h 20m (+/-5%)
- APS FLT; output indicating battery failure	- type – electronic, max 50mA/30 V DC, galvanic isolation 1500 V _{RMS}
- PSU FLT; output indicating PSU failure	- type – electronic, max 50mA/30 V DC, galvanic isolation 1500 V _{RMS}
EXT IN technical input	Voltage 'on' – 10÷30 V DC Voltage 'off' – 0÷2 V DC Level of galvanic isolation: 1500 V _{RMS}
Optical indication:	- LEDs on the PSU's PCB, - LED panel <ul style="list-style-type: none"> • output current readings • output voltage readings • failure codes with history
Acoustic indication:	- piezoelectric indicator ~75 dB /0,3 m, switchable via jumper
F _{BAT} fuse F _{MAIN} fuse	T 10 A / 250 V T 6,3 A / 250 V
Additional accessories (not included)	- RS485 'INTR' interface: RS485 communication - Ethernet 'INTE' interface; Ethernet communication

- RS485-Ethernet "INTRE" interface; RS485-Ethernet communication
--

Table 14. Mechanical parameters.

Dimensions	W=400, H=370, D+D ₁ =173+8 [+/- 2mm] W ₁ =405, H ₁ =375 [+/- 2mm]
The dimensions of the battery compartment	380 x 185 x 165mm (WxHxD) max
Mounting	See Fig. 3
Net/gross weight	9,2/10,6 kg
Enclosure	Steel plate DC01 1mm, color RAL 9005 (black)
Closing	Cheese head screw x2 (at the front), lock assembly possible
Terminals	Supply: $\Phi 0,63 \pm 2,50$ (AWG 22-10) Outputs: $\Phi 0,51 \pm 2$ (AWG 24-12), BAT battery outputs: 6,3F-2,5, 30cm
Notes	The enclosure does not adjoin the assembly surface so that cables can be led. Convictional cooling.

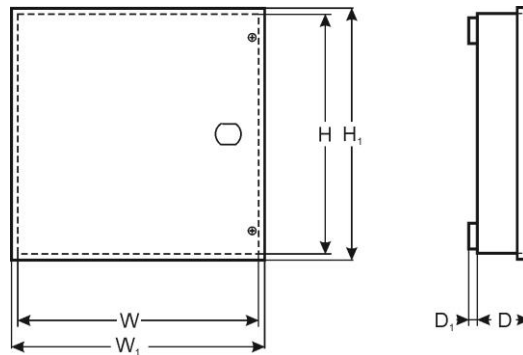
**Table 15. Safety of use.**

Protection class EN 60950-1:2007	I (first)
Protection grade EN 60529: 2002 (U)	IP20
Insulation electrical strength: - between input (network) circuit and the output circuits of the PSU - between input circuit and protection circuit - between output circuit and protection circuit	3000 V AC min. 1500 V AC min. 500 V AC min.
Insulation resistance: - between input circuit and output or protection circuit	100 M Ω , 500 V DC

9. Technical inspections and maintenance.

Technical inspections and maintenance can be performed after disconnecting the power supply from the power network. The PSU does not require any specific maintenance; however, its interior should be cleaned with compressed air if it is used in dusty conditions. In case of fuse replacement, use only compatible replacement parts.

Technical inspections should be carried out not less frequently than once per year. During the inspection, check the batteries and run the battery test.

4 weeks after installation, re-tighten all screw connections, see Fig. 2 [9].



WEEE LABEL

According to the European Union WEEE Directive, waste electrical and electronic equipment should be disposed of separately from normal household waste. Waste electrical and electronic equipment must not be disposed of with normal household waste.



CAUTION! The power supply unit is adapted for cooperation with the sealed lead-acid batteries (SLA). After the operation period they must not be thrown but recycled according to the applicable law

Pulsar sp. j.

Siedlec 150, 32-744 Łapczyca, Poland
Phone (+48) 14-610-19-40, Fax (+48) 14-610-19-50
E-mail: biuro@pulsar.pl, sales@pulsar.pl
http:// www.pulsar.pl, www.zasilacze.pl